

User Manual

GT-2744 Digital Output Module

4 digital relay output, [24 VDC, 2A], [48 VDC, 0.8 A], [110 VDC, 0.5 A], [240 VAC, 2 A], cage clamp, 10 pt removable terminal

Doc ID: 74534
2025-02-20

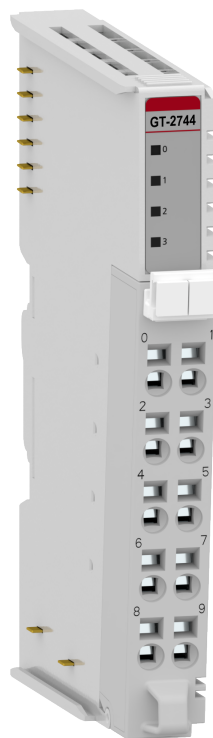

The information in this document is subject to change without notice and is provided as available at the time of printing. Beijer Electronics AB reserves the right to change any information without updating this publication. Beijer Electronics AB assumes no responsibility for any errors that may appear in this document. All examples in this document are only intended to improve understanding of the functionality and handling of the equipment. Beijer Electronics AB cannot assume any liability if these examples are used in real applications. In view of the wide range of applications for this software, users must acquire sufficient knowledge themselves in order to ensure that it is correctly used in their specific application. Persons responsible for the application and the equipment must themselves ensure that each application is in compliance with all relevant requirements, standards, and legislation in respect to configuration and safety. Beijer Electronics AB will accept no liability for any damage incurred during the installation or use of equipment mentioned in this document. Beijer Electronics AB prohibits all modification, changes, or conversion of the equipment.

Head Office

Beijer Electronics AB

Box 426

201 24 Malmö, Sweden

www.beijerelectronics.com / +46 40 358600

Table of Contents

1. About This Manual	5
1.1. Symbols Used in This Manual	5
2. Safety	6
2.1. Product Certifications	6
2.2. General Safety Requirements	6
3. About the G-series System	7
3.1. IO Process Data Mapping	8
4. Specifications	9
4.1. Environmental Specifications	9
4.2. General Specification	10
4.3. Output Specifications	11
5. Wiring Diagram	12
6. LED Indicator	13
7. Mapping Data into the Image Table	14
8. Parameter Data	15
9. Hardware Setup	16
9.1. Space Requirements	16
9.2. Mount Module to DIN Rail	17
9.3. Mount Removable Terminal Block	19
9.4. Connect Cables to Removable Terminal Block	20
9.5. Field Power and Data Pins	21

1. About This Manual

This manual contains information on the software and hardware features of the Beijer Electronics GT-2744 Digital Output Module. It provides in-depth specifications, guidance on installation, setup, and usage of the product.

1.1. Symbols Used in This Manual

This publication includes Warning, Caution, Note and Important icons where appropriate, to point out safety-related, or other important information. The corresponding symbols should be interpreted as follows:



WARNING

The Warning icon indicates a potentially hazardous situation which, if not avoided, could result in death or serious injury, and major damage to the product.



CAUTION

The Caution icon indicates a potentially hazardous situation which, if not avoided, could result in minor or moderate injury, and moderate damage to the product.



NOTE

The Note icon alerts the reader to relevant facts and conditions.



IMPORTANT

The Important icon highlights important information.

2. Safety

Before using this product, please read this manual and other relevant manuals carefully. Pay full attention to safety instructions!

In no event will Beijer Electronics be responsible or liable for damages resulting from the use of this product.

The images, examples and diagrams in this manual are included for illustrative purposes. Because of the many variables and requirements associated with any particular installation, Beijer Electronics cannot take responsibility or liability for actual use based on the examples and diagrams.

2.1. Product Certifications

The product has the following product certifications.



2.2. General Safety Requirements



WARNING

- Do not assemble the products and wires with power connected to the system. Doing so cause an "arc flash", which can result in unexpected dangerous events (burns, fire, flying objects, blast pressure, sound blast, heat).
- Do not touch terminal blocks or IO modules when the system is running. Doing so may cause electric shock, short circuit or malfunction of the device.
- Never let external metallic objects touch the product when the system is running. Doing so may cause electric shock, short circuit or malfunction of the device.
- Do not place the product near inflammable material. Doing so may cause a fire.
- All wiring work should be performed by an electrical engineer.
- When handling the modules, ensure that all persons, the workplace and the packing are well grounded. Avoid touching conductive components, the modules contain electronic components that may be destroyed by electrostatic discharge.



CAUTION

- Never use the product in environments with temperature over 60°C. Avoid placing the product in direct sunlight.
- Never use the product in environments with over 90% humidity.
- Always use the product in environments with pollution degree 1 or 2.
- Use standard cables for wiring.

3. About the G-series System

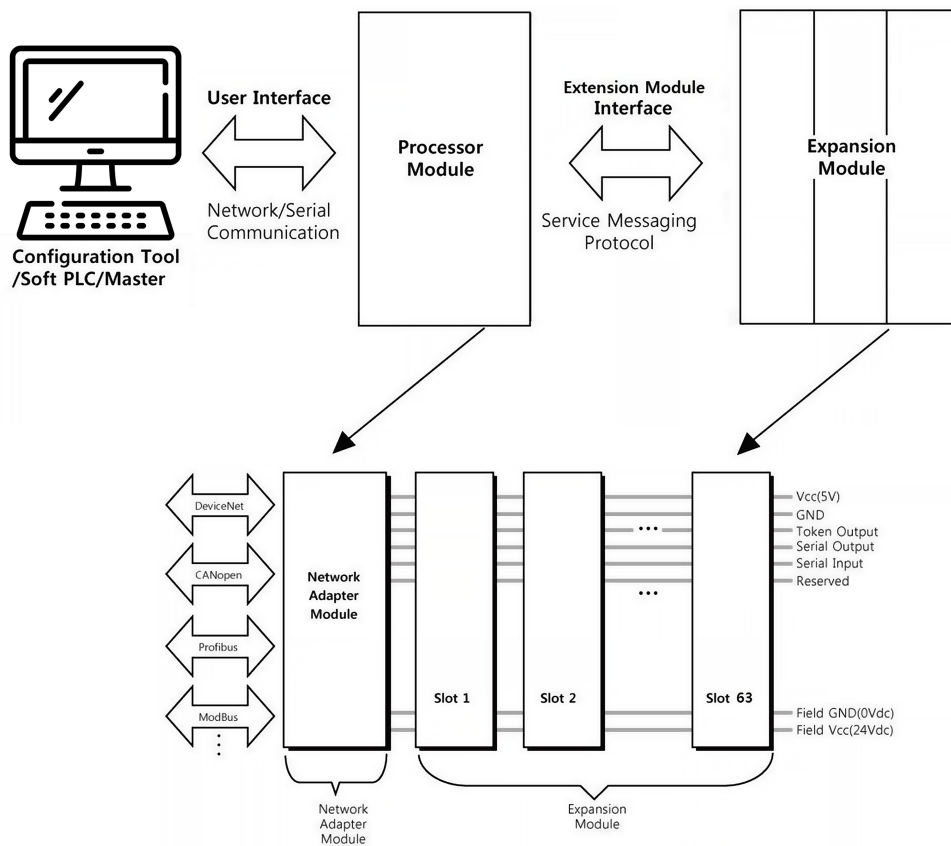

System overview

- **Network Adapter Module** - The network adapter module forms the link between the field bus and the expansion modules. The connection to different field bus systems can be established by each of the corresponding network adapter module, e.g., for MODBUS TCP, Ethernet IP, EtherCAT, PROFINET, CC-Link IE Field, PROFIBUS, CANopen, DeviceNet, CC-Link, MODBUS/Serial etc.
- **Expansion Module** - Expansion module types: Digital IO, Analog IO, and Special modules.
- **Messaging** - The system uses two types of messaging: Service messaging and IO messaging.

3.1. IO Process Data Mapping

An expansion module has three types of data: IO data, configuration parameter, and memory register. The data exchange between the network adapter and the expansion modules is made via IO process image data by internal protocol.

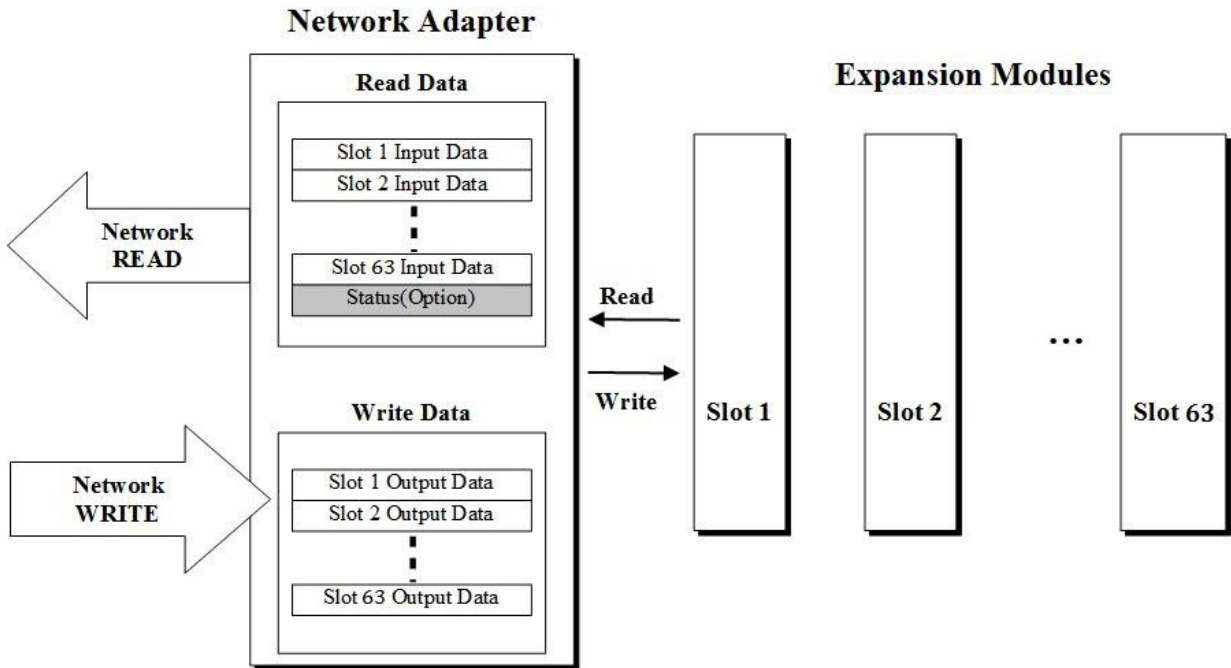

Data flow between network adapter (63 slots) and expansion modules

The input and output image data depend on the slot position and the data type of the expansion slot. The ordering of input and output process image data is based on the expansion slot position. Calculations for this arrangement are included in the manuals for network adapter and programmable IO modules.

Valid parameter data depends on the modules in use. For example, analog modules have settings of either 0-20 mA or 4-20 mA, and temperature modules have settings such as PT100, PT200, and PT500. The documentation for each module provides a description of the parameter data.

4. Specifications

4.1. Environmental Specifications

Operating temperature	-20°C - 60°C
UL temperature	-20°C - 60°C
Storage temperature	-40°C - 85°C
Relative humidity	5% - 90% non-condensing
Mounting	DIN rail
Shock operating	IEC 60068-2-27 (15G)
Vibration resistance	IEC 60068-2-6 (4 g)
Industrial emissions	EN 61000-6-4: 2019
Industrial immunity	EN 61000-6-2: 2019
Installation position	Vertical and horizontal
Product certifications	CE, FCC, UL, cUL

4.2. General Specification

Power dissipation	Max. 35 mA @ 5 VDC
Isolation	I/O to logic: Photocoupler isolation Field power: Non-Isolation
Field power	Supply voltage: 24 VDC nominal Voltage range: 22 - 26 VDC Power dissipation: 30 mA @ 24 VDC (AC power not used)
Wiring	I/O cable max. 2.0 mm ² (AWG 14)
Weight	58 g
Module size	12 mm x 99 mm x 70 mm

4.2.1. Dimensions

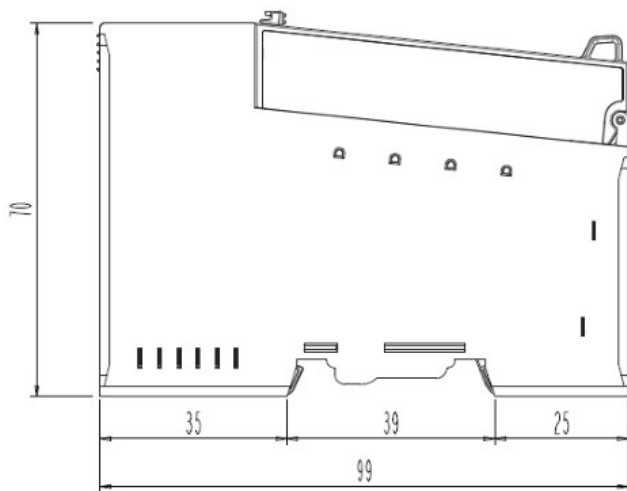

Module dimensions (mm)

4.3. Output Specifications

Output per module	4 points, bi-directional
Indicators	4 green output state
Relay type	Form A, Single Pole Single Throw (SPST)
Output voltage range (load dependent)	0 - 32 VDC @ 2 A resistive 48 VDC @ 0.8 A resistive 110 VDC @ 0.5 A resistive 240 VAC @ 2 A resistive
Output delay time (resistive load)	OFF to ON: Max. 5 ms @ 24 VAC ON to OFF: Max. 8 ms @ 24 VAC OFF to ON: Max. 5 ms @ 220 VDC ON to OFF: Max. 15 ms @ 220 VDC
Output current rating (at rated power)	2 A @ 0 - 32 VDC 0.8 A @ 48 VDC 0.5 A @ 110 VDC 2 A @ 240 VAC -40 °C - 70 °C (2 A Load 2 ch) -40 °C - 60 °C (2 A Load 4 ch)
Expected contact life	20 M cycles (resistive)
Max. on-state voltage drop *	0.5 V @ 2 A, resistive load, 24 VDC
Frequency range (VAC)	47 - 63 Hz
Common type	4 points / 2 COM

* Voltage drop specification is dependent on the cable length due to the high load.

5. Wiring Diagram

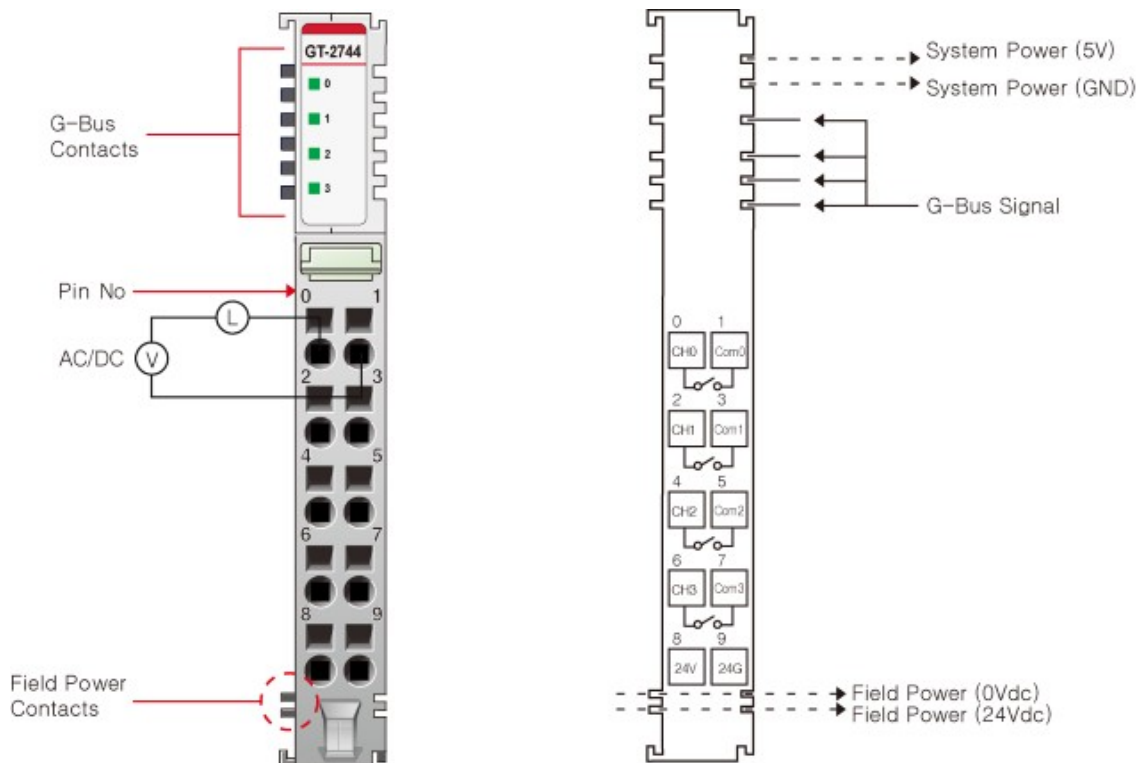

Pin no.	Signal description
0	Output channel 0
1	COM 0
2	Output channel 1
3	COM 1
4	Output channel 2
5	COM 2
6	Output channel 3
7	COM 3
8	Common (field power 24 V)
9	Common (field power 0 V)

6. LED Indicator

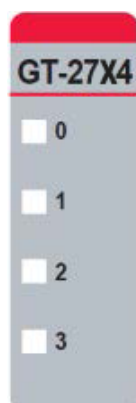

LED no.	LED function / description	LED color
0	OUTPUT channel 0	Green
1	OUTPUT channel 1	Green
2	OUTPUT channel 2	Green
3	OUTPUT channel 3	Green

Channel Status

Status	LED	Indicates
No signal	Off	No output signal
On signal	Green	Output signal transmitted

7. Mapping Data into the Image Table

Output Image Value

Bit no.	Bit7	Bit6	Bit5	Bit4	Bit3	Bit2	Bit1	Bit0
Byte0	Reserved				D3	D2	D1	D0



Output Module Data

	D3	D2	D1	D0
--	----	----	----	----

8. Parameter Data

Valid parameter length: 2 Bytes

Bit no.	Decimal bit	Description	Default value
Byte0	00-03	Fault action (0-3) 0: Fault value, 1: Hold last state	0 (fault value)
Byte1	00-03	Fault value (0-3) 0: Off, 1: On	0 (off)

9. Hardware Setup



CAUTION

- Always read this chapter before installing the module!
- Hot surface! The surface of the housing can become hot during operation. If the device is used in high ambient temperatures, always let the device cool down before touching it.
- Working on energized devices can damage the equipment! Always turn off the power supply before working on the device.

9.1. Space Requirements

The following drawings show the space requirements when installing the G-series modules. The spacing creates space for ventilation, and prevents conducted electromagnetic interference from influencing the operation. Installation position is valid vertical and horizontal. The drawings are illustrative and may be out of proportion.



CAUTION

NOT following the space requirements may result in damaging the product.

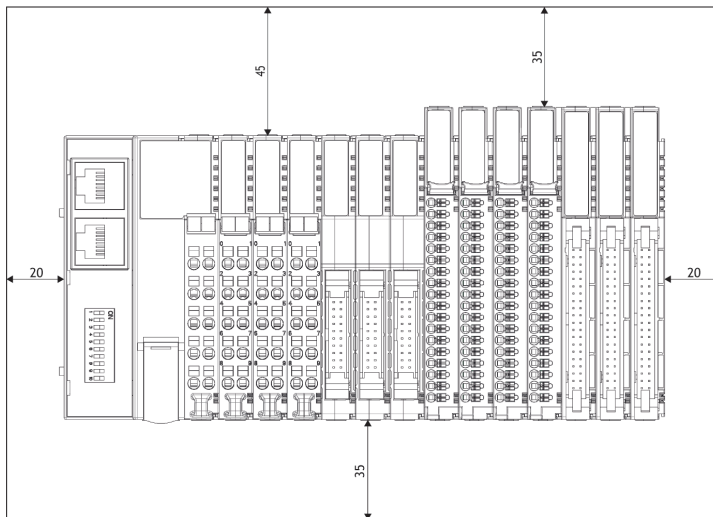

Vertical and horizontal space requirements

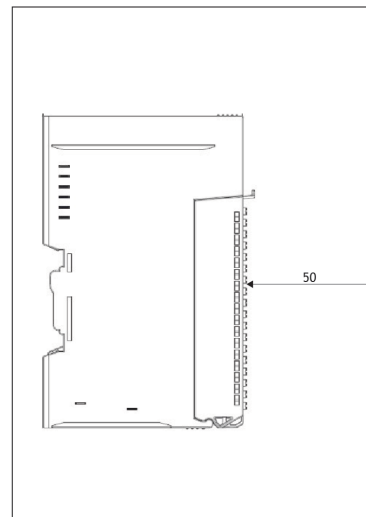

Required distance to door

9.2. Mount Module to DIN Rail

The following chapters describe how to mount the module to the DIN rail.



CAUTION

The module must be fixed to the DIN rail with the locking levers.

9.2.1. Mount GL-9XXX or GT-XXXX Module

The following instructions apply to these module types:

- GL-9XXX
- GT-1XXX
- GT-2XXX
- GT-3XXX
- GT-4XXX
- GT-5XXX
- GT-7XXX

GN-9XXX modules have three locking levers, one at the bottom and two on the side. For mounting instructions, refer to [Mount GN-9XXX Module](#).

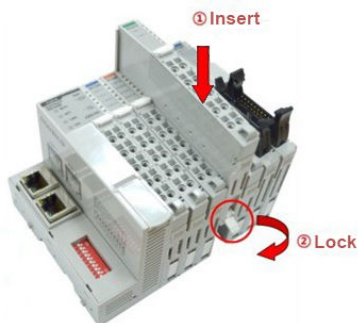

Mount to DIN rail

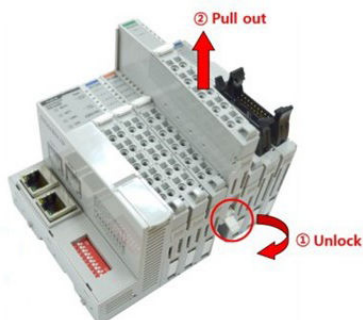

Dismount from DIN rail

9.2.2. Mount GN-9XXX Module

To mount or dismount a **network adapter** or **programmable IO** module with the product name **GN-9XXX**, for example GN-9251 or GN-9371, see the following instructions:

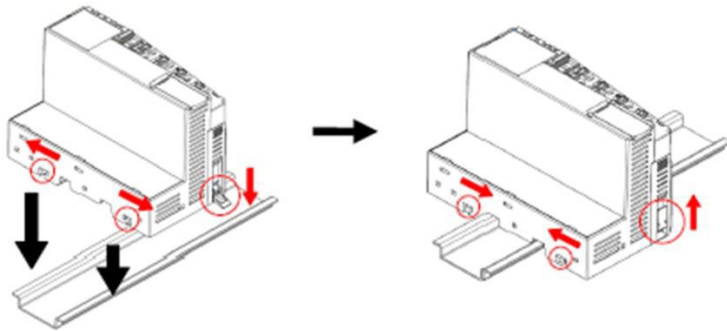

Mount to DIN rail

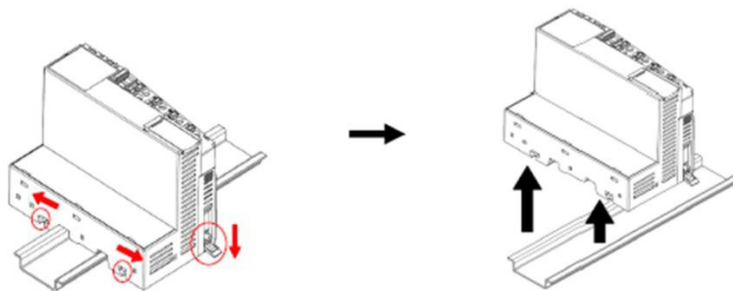

Dismount from DIN rail

9.3. Mount Removable Terminal Block

To mount or dismount a removable terminal block (RTB), see the instructions below.

① **Insert**



② **Lock**



Mount a removable terminal block

① **Unlock**



② **Pull out**



Dismount a removable terminal block

9.4. Connect Cables to Removable Terminal Block

To connect/disconnect cables to/from the removable terminal block (RTB), see the instructions below.

 **WARNING**
Always use the recommended supply voltage and frequency to prevent damage to the equipment and ensure optimal performance.

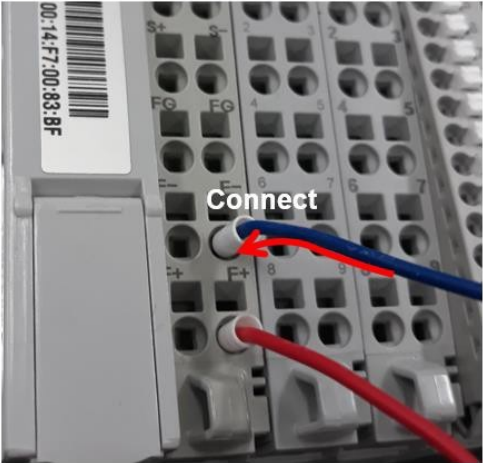

Connect cable

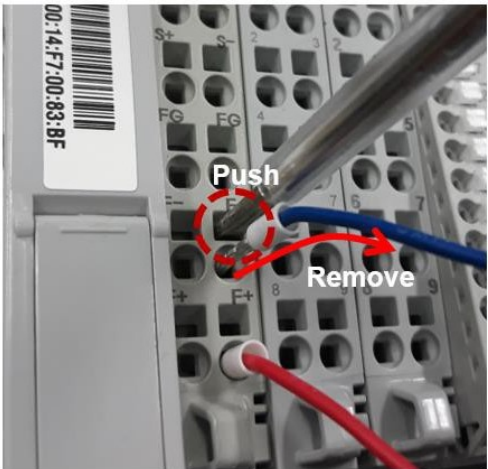

Disconnect cable

9.5. Field Power and Data Pins

Communication between the G-series network adapter and the expansion module, as well as system / field power supply of the bus modules is carried out via the internal bus. It is comprised of **2 Field Power Pins** and **6 Data Pins**.



WARNING

Do not touch the data and field power pins! Touching can result in soiling and damage by ESD noise.

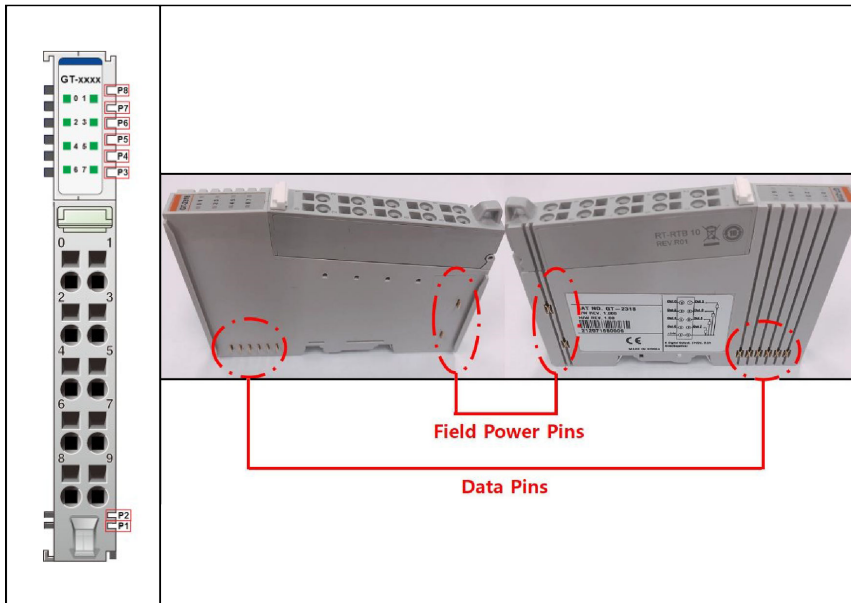

Pin no.	Name	Description
P1	System VCC	System supply voltage (5 VDC)
P2	System GND	System ground
P3	Token output	Token output port of processor module
P4	Serial output	Transmitter output port of processor module
P5	Serial input	Receiver input port of processor module
P6	Reserved	Reserved for bypass token
P7	Field GND	Field ground
P8	Field VCC	Field supply voltage (24 VDC)

